

Features

- Low On-Resistance
- Ideal for Notebook Computer, Portable Phone, PCMCIA Cards, and Battery Powered Circuits
- **Lead Free By Design/RoHS Compliant (Note 2)**
- **Qualified to AEC-Q101 Standards for High Reliability**
- **ESD Protected Gate**
- **"Green" Device (Note 3)**

Mechanical Data

- Case: SC-59
- Case Material - Molded Plastic, "Green" Molding Compound. UL Flammability Classification Rating 94V-0
- Moisture Sensitivity: Level 1 per J-STD-020C
- Terminals: Finish Matte Tin annealed over Copper leadframe. Solderable per MIL-STD-202, Method 208
- Terminal Connections: See Diagram
- Marking Information: See Page 3
- Ordering & Date Code Information: See Page 3
- Weight: 0.008 grams (approximate)



ESD Protected



TOP VIEW

SC-59

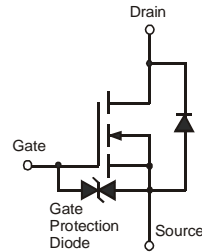

EQUIVALENT CIRCUIT

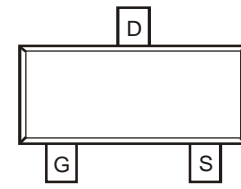
 TOP VIEW
Pin Out Configuration

Maximum Ratings @_{T_A} = 25°C unless otherwise specified

Characteristic	Symbol	Value	Units
Drain-Source Voltage	V_{DSS}	20	V
Gate-Source Voltage	V_{GSS}	± 8	V
Drain Current	Continuous	1.2	A
	Pulsed	4.0	A

Thermal Characteristics @_{T_A} = 25°C unless otherwise specified

Characteristic	Symbol	Value	Units
Total Power Dissipation	P_d	500	mW
Thermal Resistance, Junction to Ambient	$R_{\theta JA}$	250	°C /W
Operating and Storage Temperature Range	T_j, T_{STG}	-55 to +150	°C

Electrical Characteristics @_{T_A} = 25°C unless otherwise specified

Characteristic	Symbol	Min	Typ	Max	Unit	Test Condition
OFF CHARACTERISTICS (Note 1)						
Drain-Source Breakdown Voltage	BV_{DSS}	20	—	—	V	$V_{GS} = 0V, I_D = 250\mu A$
Zero Gate Voltage Drain Current	I_{DSS}	—	—	10	μA	@ $T_j = 25^\circ C$ $V_{DS} = 20V, V_{GS} = 0V$
Gate-Body Leakage	I_{GSS}	—	—	± 10	μA	$V_{GS} = \pm 8V, V_{DS} = 0V$
ON CHARACTERISTICS (Note 1)						
Gate Threshold Voltage	$V_{GS(th)}$	0.5	—	1.2	V	$V_{DS} = 10V, I_D = 1.0mA$
Static Drain-Source On-Resistance	$R_{DS(on)}$	—	—	0.10	Ω	$V_{GS} = 4.5V, I_D = 0.5A$
		—	—	0.14		$V_{GS} = 2.5V, I_D = 0.5A$
		—	—	0.25		$V_{GS} = 1.5V, I_D = 0.1A$
Forward Transfer Admittance	$ Y_{fs} $	—	4.2	—	S	$V_{DS} = 10V, I_D = 0.5A$
Diode Forward Voltage	V_{SD}	—	0.8	1.1	V	$V_{GS} = 0V, I_S = 1A$
DYNAMIC CHARACTERISTICS						
Input Capacitance	C_{iss}	—	220	—	pF	$V_{DS} = 10V, V_{GS} = 0V$ $f = 1.0MHz$
Output Capacitance	C_{oss}	—	120	—	pF	
Reverse Transfer Capacitance	C_{rss}	—	45	—	pF	
SWITCHING CHARACTERISTICS						
Turn-On Delay Time	$t_{D(ON)}$	—	10	—	ns	$V_{DD} = 5V, I_D = 0.5A,$ $V_{GS} = 10V, R_{GEN} = 50\Omega$
Turn-Off Delay Time	$t_{D(OFF)}$	—	75	—	ns	
Turn-On Rise Time	t_r	—	15	—	ns	
Turn-Off Fall Time	t_f	—	65	—	ns	

- Notes:
1. Pulse width ≤ 300μs, duty cycle ≤ 2%.
 2. No purposefully added lead.
 3. Diodes Inc.'s "Green" Policy can be found on our website at http://www.diodes.com/products/lead_free/index.php.

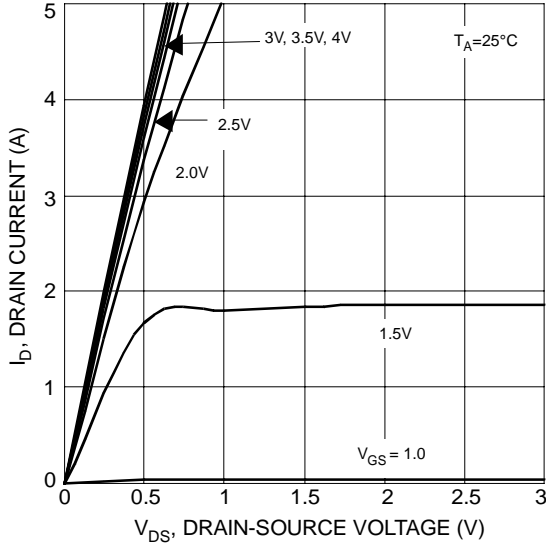

Fig. 1 Typical Output Characteristics

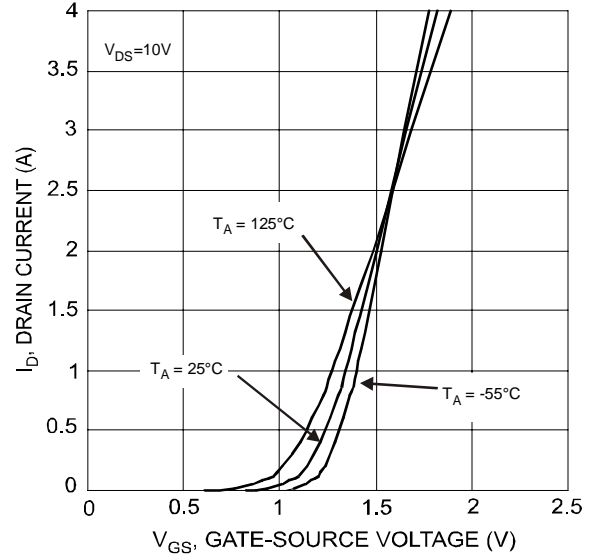

Fig. 2 Typical Transfer Characteristics

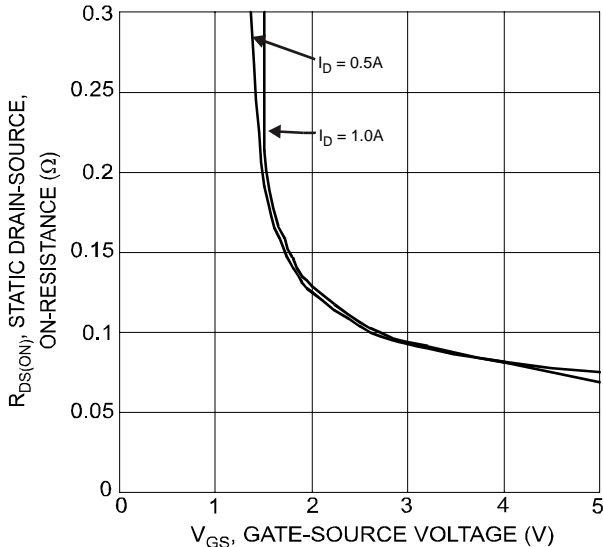

Fig. 3 On-Resistance vs. Gate Voltage

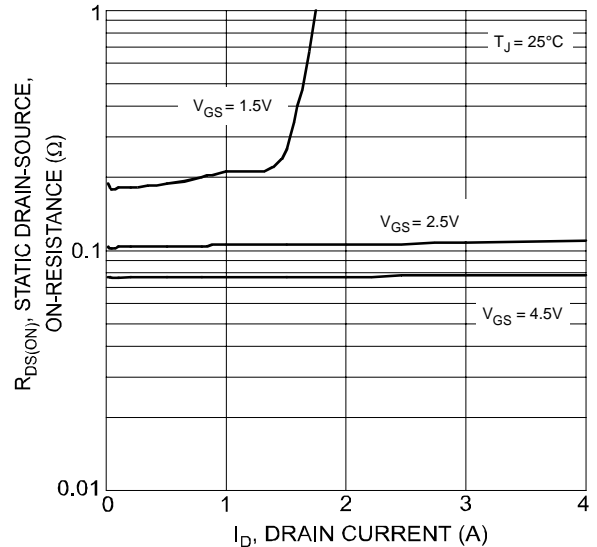

Fig. 4 On-Resistance vs. Drain Current

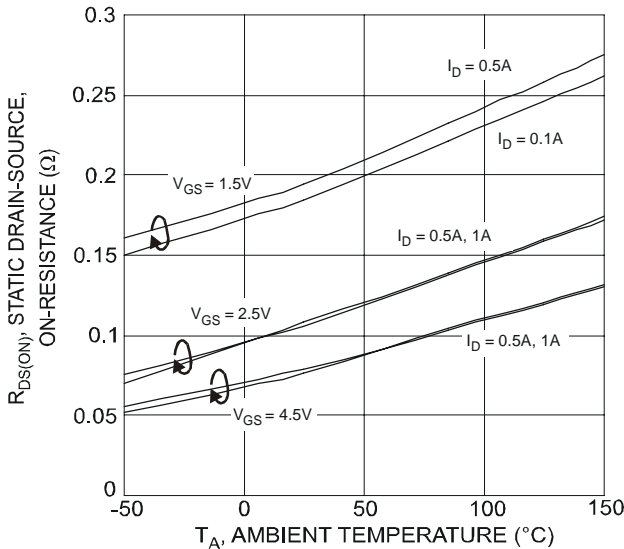

Fig. 5 On-Resistance Variation with Temperature

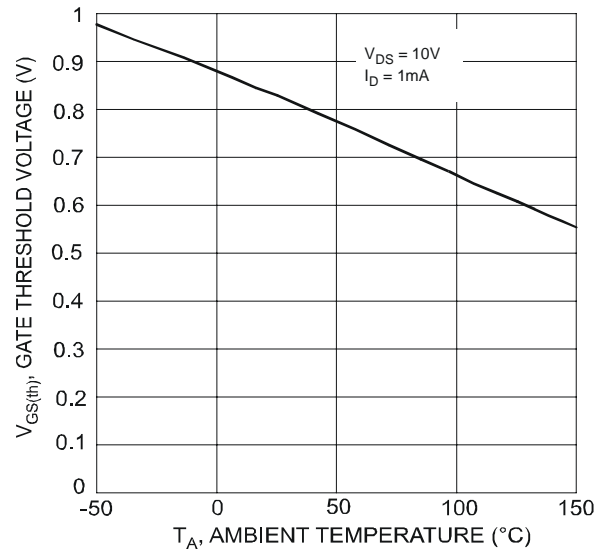
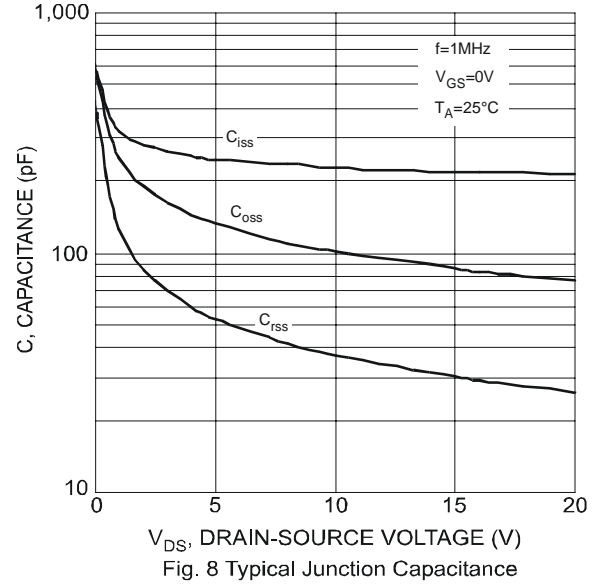
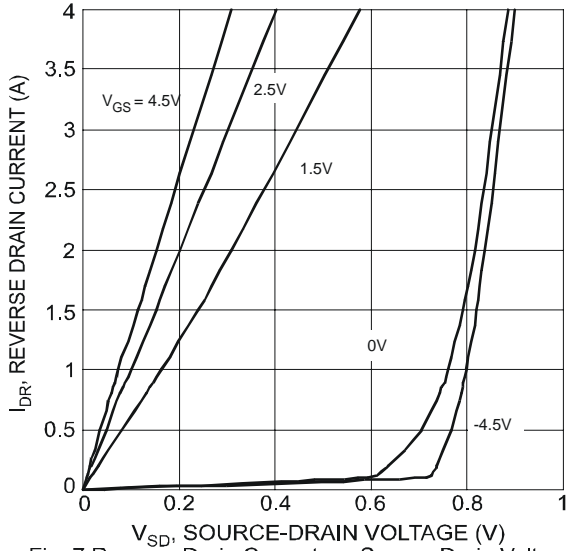

Fig. 6 Gate Threshold Voltage vs. Temperature



Ordering Information (Note 4)

Part Number	Case	Packaging
DMN2112SN-7	SC-59	3000/Tape & Reel

Notes: 4. For packaging details, go to our website at <http://www.diodes.com/datasheets/ap02007.pdf>.

Marking Information

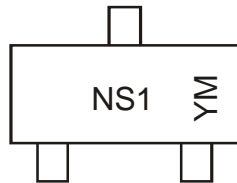

NS1 = Product Type Marking Code
 YM = Date Code Marking
 Y = Year ex: T = 2006
 M = Month ex: 9 = September

Date Code Key

Year	2007	2008	2009	2010	2011	2012
Code	U	V	W	X	Y	Z

Month	Jan	Feb	Mar	Apr	May	Jun	Jul	Aug	Sep	Oct	Nov	Dec
Code	1	2	3	4	5	6	7	8	9	O	N	D

Package Outline Dimensions

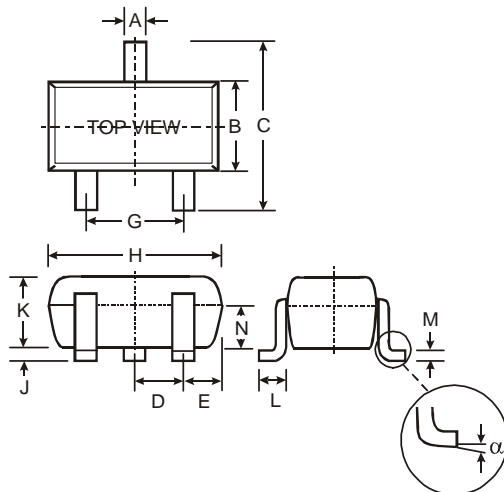

SC-59		
Dim	Min	Max
A	0.35	0.50
B	1.50	1.70
C	2.70	3.00
D	0.95	
E	—	
G	1.90	
H	2.90	3.10
J	0.013	0.10
K	1.00	1.30
L	0.35	0.55
M	0.10	0.20
N	0.70	0.80
α	0°	8°
All Dimensions in mm		

Suggested Pad Layout

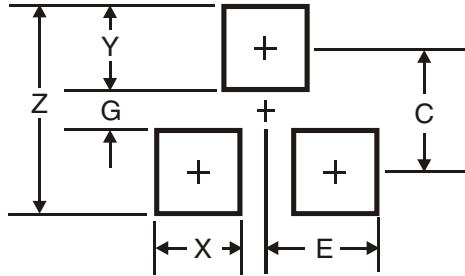

Dimensions	Value (in mm)
Z	4.0
G	1.2
X	0.9
Y	1.4
C	2.6
E	0.95

IMPORTANT NOTICE

Diodes Incorporated and its subsidiaries reserve the right to make modifications, enhancements, improvements, corrections or other changes without further notice to any product herein. Diodes Incorporated does not assume any liability arising out of the application or use of any product described herein; neither does it convey any license under its patent rights, nor the rights of others. The user of products in such applications shall assume all risks of such use and will agree to hold Diodes Incorporated and all the companies whose products are represented on our website, harmless against all damages.

LIFE SUPPORT

Diodes Incorporated products are not authorized for use as critical components in life support devices or systems without the expressed written approval of the President of Diodes Incorporated.